

dial EZY



IRRIGATION CONTROLLER

4, 6 OR 8 STATION MODELS

INSTRUCTION MANUAL

SUITABLE FOR INDOOR USE ONLY
OTHERWISE WARRANTY IS VOID

HOLMAN
Innovation in Watering

Table Of Contents

Features	1
Glossary	2
Programming Instructions	
Introduction	3
Other Functions	4
General tips for programming	4
Programming Example	4-5
Programming	
Set Current Time & Correct Day	6
Set Calendar (Optional)	6
Step 1. Set Start Times	7
Step 2. Set Watering Days	8
Interval Day Selection	8
Individual Day Selection	8
Odd / Even Day Selection	9
Step 3. Set Station Run Times	9-10
Manual Operations	
Run A Single Station	11
System test facility	11
Run A Program	11
Other Features	
Stop	12
Stacking Start Times	12
Automatic BackUp Program	12
Rain Delay	13
Rain Off Mode	14
Water Budgeting	14
Installation Instructions	
Mounting The Controller	15
Electrical Hook-Up	15
Field Wiring Connections	16
Terminal Block Layout	16
Power Supply Connections	17
Connection Of Valves	17
Pump Hook-Up Connections	18
Electrical Characteristics	19
Servicing The Controller	20
Fault Finding Guide	21
Spare Watering Planners	22-25

Features

This unit is available in four, six and eight station configurations.

Designed for residential and light commercial applications, this controller has two separate schedules with up to eight start times a day to ensure efficient watering of different garden or turf areas.

These different areas may require individual watering schedules and often use different types of sprinklers.

Examples: Turf areas generally use pop-up sprinklers and require less frequent but heavier watering. However, flower beds use micro sprays and require more frequent watering. The valves (stations) which water similar garden areas are often grouped together and put into the same program as they need to be watered on the same days.

These stations (valves) will water in sequential order from the lowest number at the start time (or times) nominated and on the days selected. Maximum watering duration for a station (valve) is 12 hours and 59 minutes.

This controller has a 7 day watering schedule with individual day selection per program or a 365 calendar for Odd/Even day watering or selectable interval watering schedules from everyday to every 15th day.

A key feature of this controller is the water saver feature which allows quick adjustment of the station watering times by percentages as the seasons change.

Glossary

Programming Instructions

Introduction

This controller has been designed with two separate programs to allow the different garden areas to have their own individual watering schedules.

A program is basically a method of grouping stations (valves) with similar watering requirements to water on the same days. These stations will water in sequential order from the lowest number at the start time (or times) nominated and on the days selected.

The important elements of programming your controller are:

- **Group the stations** (valves) which are watering similar garden areas together.

Examples: Turf, flower beds, pergola areas, vegetables. These different groups may require individual watering schedules.

- **Plan your watering schedule** and write the information on the planner supplied at the back of this book.
- **Set the current time and correct day of the week.**
- **Set the automatic program** for each group by completing the following 3 steps.

1 Set Starts.

This sets the time when the watering schedule is to commence.

2 Set Watering Days.

These are the nominated days when the automatic system will be active.

3 Set Station Run Times.

This sets the watering duration required for each station (valve).



Operations and Programming Selection Dial

Programming Adjustment Buttons





Programming Instructions

Other Functions

This controller can also manually run a selected program once, or an individual station can be set to run once from 1 minute up to 12 hours and 59 minutes. During winter the automatic schedules can be suspended to prevent watering while it is raining. A test facility for checking the valves and sprinklers is also provided.

General tips for easy programming

Tips to help eliminate programming confusion.

- Complete the spare watering planner.
- When setting, one push of the button will increment one unit.
- Holding one button down will fast scroll through units.
- During programming, flashing units are able to be set, using  or  buttons
- Pressing  will scroll forward through the settings in an orderly sequence.
- Pressing  will scroll back to previous settings and settings can be changed.

Programming Example

A typical example of a 8 station system is included on the following page as a guide to assist you when planning your watering schedule.

In this example, the lawn areas are using pop-ups and require less frequent watering.

The vegetables are being watered using drippers, and the flower beds and pergola areas are being watered with micro sprays.

Programming Example (cont.)



Example: 8 Station Controller

STN. NO	GARDEN AREA	PROGRAM NO	STATION WATERING DURATION	WATERING START TIME(S)	FREQUENCY OF WATERING
1	Front Lawn	1	20 Mins	4.00AM	Mon, Wed, Fri
2	Front Lawn	1	20 Mins		
3	Front Lawn	1	20 Mins		
4	Vegetables	2	30 Mins	6.00AM	Every Day
5	Flower Bed	2	10 Mins	6.00AM	Every Day
6	Flower Bed	2	10 Mins		
7	Back Lawn	1	20 Mins	4.00AM	Mon, Wed, Fri
8	Pergola	2	5 Mins	6.00AM	Every Day

Programming

Set Current Time & Correct Day



Turn the dial to **Set Clock/Calendar** position. The hour will be flashing.

Use  or  to adjust. Note: AM / PM must be set correctly.

Press the **next** button and the “minutes” will flash. Use  or

 to adjust.



Press **next** and the “day of the week” will flash.

Use  or  to set correct day.

Set Calendar (Optional)

Note: The calendar only needs to be set when selecting Odd/Even day watering in areas where water restrictions may require this feature.

Press **back** button until the year, month and day are shown. the “year” will be flashing.

Use  or  to adjust, if required.

Press **back** button and the “month” will flash.

Use  or  to adjust.

Press **back** and the “day” will flash.

Use  or  to adjust.

Tip: To return to the clock, press **next**, or turn dial to another position.

Programming

Before proceeding, ensure the spare watering planner has been completed. From your planner you should be aware which stations are allocated to each program.

Set one program at a time to ensure that the schedules are completed correctly.

Example: **SET PROGRAM 1**



Step 1. Set Start Times



Turn the dial to **Set Start Times** and ensure that “Prog 1” is flashing.

The display will show:



Press **next** and “Start 1” will flash..

Press **next** and the “hour” will flash. Use  or  to adjust. Note: Ensure AM / PM position is correct

Press **next** and the “minutes” will flash. Use  or  to adjust, if required. Each program has up to four start times and should you require a second start time,



Press **next** and “Start1” will flash. Advance to start 2 by pressing .

The display will show.



Press **next** and proceed as per setting **Start 1**.

Tip: To turn an active start time off, turn the dial to the **Set Start times** position, *Select* the start number required

using the  button and then press **next** until the “hour” is flashing. Use  or  until “OFF” is shown.

Tip: “OFF” position is between 12 and 1.

Programming

Step 2. Set Watering Days

This unit has interval watering or individual day selection from everyday to every 15th day or a 365 day calendar with odd/even day selection in areas where water restrictions require this feature.

Turn the dial to **Set Watering Days**.

Interval Day Selection

The display will show:

“Interval 1” will be flashing.



This means that watering will occur every day.

To change the interval day, **press** the  button.

Examples: Interval 2 means watering will take place every second day, 3 means watering will take place every third day etc.

Interval watering can be set from everyday to every 15th day. The *Run Day* refers to the number of days before the next watering schedule will occur.

Individual Day Selection



Press the  button

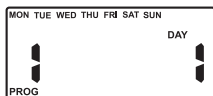

This is the **selectable** day option.



The display will show:



This refers to Mon being Day 1. To turn Monday off, **press**

 button. To leave Monday active, leave as is and advance to Tuesday (day 2) by **pressing** the  button.

Again **press** the  button to set the day off if required followed by  to advance. Continue until all seven



days have been set “on”  or “off” .

Programming

Odd / Even Day Selection (Optional)

In some regions users are only allowed to water their gardens on ODD dates if their house number is ODD, or on EVEN dates when their number EVEN .

This controller allows this to be done simply by setting the relevant selection of ODD or EVEN and setting the current date into the controller. The controller will account for leap years.

If you require the ODD / EVEN day option, simply **press** the  button until “Odd” is shown. **Press** the  button and “Even” will be shown. This feature may be required in areas where water restrictions are enforced.

Note: Remember to set the 365 day calendar when setting the clock, or this feature will be out of sequence.

Step 3. Set Station Run Times

This is the length of time that each station (valve) is scheduled to water on a particular program. Maximum watering time is 12 hours 59 minutes for each station. A station can be assigned to 1 or 2 programs if required.

Turn the dial to the **Set Station Run Times** position and the display will show the following:



This means station 1 has a default run time of 10 minutes in program 1. Station 1 will be flashing.

Programming

Step 3. Set Station Run Times. (Continued)

To adjust the **Run time** in minutes **press** **next**, and use **▲** or **▼**. To set the run time in hours, **press** **next** and “0” will appear and flash. To adjust use **▲** or **▼**. If not required **press** **next** and advance to station 2 by pressing the **▲** button.

Continue until all the stations in Program1 have been set with a run time or if a station (or stations) is not required to be active in this particular program, ensure that the Run time is set to “OFF”.

Note: To set a station to “OFF”. Use **▼** when the “**RUN TIME**” is flashing.

This completes the setting up procedure for automatic watering of Program 1.

Should you need the second program to have an automatic schedule, **turn** the dial to “Set Start times” and “Prog 1” will flash. **press** **▲** and change to program 2 position and follow the same 3 steps for automatic watering.

1. **Set Starts**
2. **Set Watering Days**
3. **Set Station Run Times**

Tip: Remember to return the dial to the “Auto Run” position at the completion of the setting up of the automatic schedules. This will ensure that the automatic cycles will take place.

Manual Operations

Run A Single Station

The maximum Run time for a station is 12 hours 59 minutes. To manually run a single station once, **turn** the dial to **Run Single Station** position and the display will show:



To adjust the Run Time, use the **▲** button and to advance to the next station **press** the **next** button.

System Test Facility

This feature can be used to test that your valves and sprinklers are working correctly. **Turn** the dial to **Run Test Cycle** and the display will show:



The controller will run through all stations for 2 minutes in sequential order while you go and check your sprinklers. Note: The system test facility is preset at 2 minutes per station and can be adjusted using **▲** or **▼**.

Run A Program

To manually run a complete program once for the run times as set in the automatic schedule. **Turn** the dial to the **Run Program** position. “Prog 1” will be shown in the display. To run program 1, leave or advance to program 2 by **pressing** **next**.

Other Features

Stop

To stop an automatic or manual watering schedule, **turn** the dial to the **Off** position.

Tip: for automatic watering remember to **turn** the dial back to the **Auto Run** position, as the **Off** position will stop any watering cycles from occurring.

Stacking Start Times

Should you accidentally set the same watering start time on more than one program, the Controller will stack them in sequential order from the lowest number. All programmed start times will be watered, but the start times will be shunted along.

Automatic BackUp Program

When the battery is not fitted or is flat there is a backup default program in program 1 watering every day at 12:00am for 10 minutes per station.

A standard 9 volt alkaline block battery should be fitted to the battery snap supplied to maintain the clock accuracy and hold the automatic programs during power outs.

Tip: The display has a warning indicator to let you know when the battery is low or not fitted. The word **BAT** appears just under the AM / PM indicator when the clock is shown.

Other Features

Rain Delay

After heavy rain it may be appropriate to delay the start of the automatic watering schedules for a few days. Turn

the dial to “OFF” and press the  button.

The display will show:





This means that the automatic watering schedules will be delayed for 24 hours.

Tip:

Leave the dial in the “OFF” position, and at the end of the 24 hour delay the controller will automatically revert back to the clock in the display and the next automatic watering schedule will take place.

Tip:

- The delay is in 24 hour increments and can be set up to 240 hours using the  button. Each time the  button is pressed another 24 hours delay will be added.
- The display will count down every hour.
- To clear the delay, turn the dial from “OFF” position to “Auto Run” position.

Other Features

Rain Off Mode

To stop the automatic watering cycles during winter, **turn** the dial to the **Off** position. The word “Off” will appear in the display. This means the automatic schedules will not come on, but the programmed information is still retained in the memory. To reactivate the automatic schedule, **turn** the dial back to the **Auto Run** position.

Water Budgeting

The automatic station run times can be adjusted by percentage as the seasons change. This will save time and money as the run times can be adjusted quickly in spring, winter and autumn to reduce the amount of water used.

Ensure that the dial is in the **Auto Run** position and then **press** the **back** and **next** buttons simultaneously.

The display will show:



Displayed is the word “Budget” and “100%”. This represents the current automatic watering run times as being 100%. The percentage budget can be set in 25% increments from 25% up to 150%.

Example: 50% reduces watering by half.

To adjust in 25% increments, use  or  buttons.

To return to the clock **press** the **back** and **next** buttons simultaneously. The display will show the word *Budget* to indicate that the water budgeting feature is in use.

Installation Instructions

Mounting The Controller

This controller unit is an INDOOR MODEL and MUST not be exposed to rain or water ingress.

(If the controller needs to be outdoors, you can purchase a HOLMAN outdoor weatherproof box to mount the controller inside. This box is available from your irrigation supplier.)

Install the controller near a 240V AC mains outlet, preferably located in a house, garage or other covered area. For ease of operation, eye level placement is recommended.

Drive one #8 screw into the wall, leaving about 4mm of the screw exposed. If necessary, use a toggle bolt or masonry shield.

Hang the controller from the key slot located in the back of the case. Make sure the head is properly seated inside the controller case. Additional screws may be inserted through the holes in the lower corners of the controller case.

Electrical Hook-Up

WARNING

- 1 All electrical work must be carried out in accordance with these instructions following all applicable Local, State and Federal codes, or warranty will be void.**
- 2 Disconnect mains power supply before maintenance work to controller or valves and when connecting and disconnecting field wiring and pump or master valve hook-ups.**

Installation Instructions

Field Wiring Connections

PREPARATION

- 1 Prepare wires for hook-up by cutting the wires to the correct length and stripping approximately 6.0mm (¼ inch) of insulation from the end to be connected to the controller.
- 2 Ensure terminal block screws are loosened sufficiently to permit easy access for wire ends. Insert stripped wire ends into the clamp aperture and tighten screws. *Do not over* tighten as this may damage the terminal block.
- 3 A maximum of 0.5 Amps may be supplied by any output. Check the inrush current of your solenoid coils before connecting more than two valves to any one station.

Terminal Block Layout

The terminal block is laid out as follows:

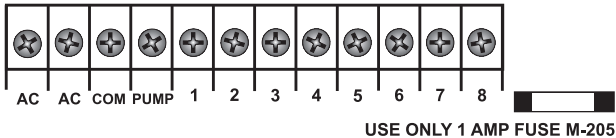

GLOSSARY

AC	24VAC Power Supply
COM	Common valve wire input
PUMP	Master valve or pump start active wire
ST1 to ST8	Station (Valve) active wire connection

Installation Instructions

Power Supply Connections

The controller itself can run off a 240V AC to 24VAC Plugpack.

It is recommended that the transformer is not connected to a 240V AC supply which is also servicing or supplying motors (i.e. Air conditioners, pool pumps, refrigerators, etc.) Lighting circuits are suitable as a power source.

Connections to the unit are as follows:

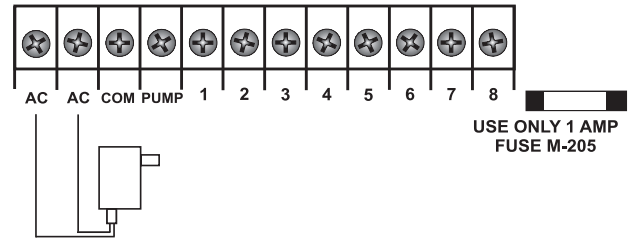

Connection Of Valves

Up to two 24VAC Solenoid Valves can be connected to each station output and wired back to the common (COM) thus:

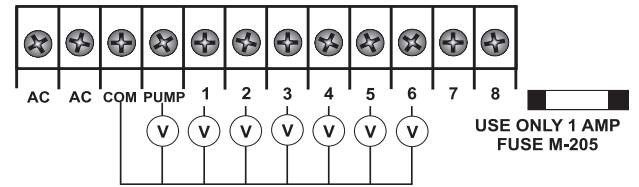

Valve wires enter the controller through the rear

Installation Instructions

Pump Hook-Up Connections

Do not attempt to drive a pump starter directly from the controller. Pump start is provided by connecting one side of the coil of a suitable relay to the Master Valve/Pump Start output of the controller and the other side to the controller common.

For systems supplied with water from a Pump, unused stations must be connected back to the last used station to eliminate the possibility of the pump running against a closed head. Failure to do so could lead to pump damage.

The diagram shows a 6 Station Controller:

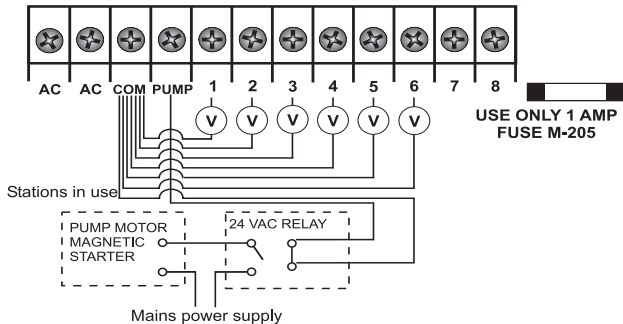

Electrical Characteristics

Power Supply

MAINS SUPPLY

This unit can run off a 50Hz Plugpack Transformer with an output of 24VAC 50Hz @ 1 Amp.

Plug Pack Model

The correct wiring installation for the 24VAC Plug Pack is shown on page 17. The Plug Pack Model is only suitable for indoor installation.

Electrical Outputs

ELECTRICAL POWER SUPPLY

- Input: 24Volts AC 50Hz.
- Electrical Outputs:
Maximum of 1.0 AMP

To Solenoid Valves - 24 VAC 50/60 Hz 0.5 AMPS max.

To the Master Valve/Pump Start - 24VAC 0.25 AMPS max.

Note:

Transformer and fuse capacity must be compatible with output requirements.

- Overload protection:- Standard 20mm 1 Amp fuse.
- Power failure: 9 Volt block type battery maintains clock and programs for up to 4 weeks.
- The output circuits should be installed and protected in accordance with wiring rules.

Servicing The Controller

The Controller should always be serviced by an authorized agent.

Follow these steps:

- 1 Turn Mains power off to the controller.
- 2 Disconnect 24 Volt power leads from the PLUG PACK at the controller 24VAC terminals.
- 3 Clearly mark or identify all valve wires according to the terminals they are connected to, (1 to 8). This allows you to easily wire them back to the Controller, maintaining your valve watering sequence.
- 4 Disconnect valve wires from the terminal block.
- 5 Remove the complete unit from the wall.
- 6 Carefully wrap the complete unit in protective wrapping and pack in a suitable box. Return to your service agent or the manufacturer.
Note: Tampering with the unit will cancel the Guarantee
- 7 Replace your controller by reversing this procedure.

Fault Finding Guide

Symptom	Possible Cause	Suggestion
No display.	Faulty transformer. Fuse blown.	Check fuse. Check field wiring. Check transformer.
Single Station not working.	Faulty solenoid coil.	Swap faulty station wire on controller terminal block with known working station wire. If the faulty valve still does not work on the known working connection then the solenoid coil is faulty. The panel may need to be repaired.
Fuse blows.	Incorrect wiring or bad wiring joint.	Check wiring and joints.
No automatic start.	Incorrect programming or blown fuse.	If unit works manually check programming. Check fuse and field wiring.
Buttons on keypad not responding.	Short on keypad or Programming not correct.	Check instruction book to ensure programming correct. If keypad still not responding return panel to supplier or manufacturer.
System coming on at random.	Short on keypad or too many start times entered on automatic programs.	Check number of start times entered on each program. If programming is correct return panel to supplier or manufacturer.
More than 1 station coming on at once.	Damaged main output driver chip.	Check wiring and swap faulty station wire(s) on controller terminal block with known working station wire. If the same outputs are still locked on, return panel to supplier or manufacturer.
Pump start chattering.	Faulty relay or pump contactor.	Electrician to check voltage on pump relay or contactor.
Display cracked or missing segments.	Display damaged during transportation.	Return panel to supplier or manufacturer.

Spare Watering Planner

STN. NO	GARDEN AREA	PROGRAM NO	STATION WATERING DURATION	WATERING START TIME(S)	FREQUENCY OF WATERING
1					
2					
3					
4					
5					
6					
7					
8					

Spare Watering Planner

STN. NO	GARDEN AREA	PROGRAM NO	STATION WATERING DURATION	WATERING START TIME(S)	FREQUENCY OF WATERING
1					
2					
3					
4					
5					
6					
7					
8					

Spare Watering Planner

STN. NO	GARDEN AREA	PROGRAM NO	STATION WATERING DURATION	WATERING START TIME(S)	FREQUENCY OF WATERING
1					
2					
3					
4					
5					
6					
7					
8					

Spare Watering Planner

STN. NO	GARDEN AREA	PROGRAM NO	STATION WATERING DURATION	WATERING START TIME(S)	FREQUENCY OF WATERING
1					
2					
3					
4					
5					
6					
7					
8					

Your Guarantee

The manufacturer Guarantee to the original purchaser that any product supplied by the manufacturer will be free from defects in materials and workmanship for a period of one year from the date of purchase. Any product found to have defects in material or workmanship within the period of this Guarantee shall be repaired or replaced by the manufacturer **FREE OF CHARGE**.

The guarantor does not guarantee the fitness for a particular purpose of its products and does not make any guarantee, expressed or implied, other than the guarantee contained herein. The guarantor shall not be liable for any loss from use of the product or incidental or consequential damages including damages to other parts of any installation of which this product is part.

The guarantee shall not apply to any equipment which is found to have been improperly installed, set up or used in any way not in accordance with the instructions supplied with this equipment, or to have been modified, repaired or altered in any way without the express written consent of the company. This guarantee shall not apply to any batteries or accessories used in the equipment covered under this guarantee or to any damage which may be caused by such batteries.

If the Controller develops a fault, the product or panel must be returned in adequate packing with:

- 1 A copy of your original invoice.
- 2 A description of any fault.

It is the purchasers responsibility to return the Controller to the manufacturer or their agent by pre-paid freight.

HOLMAN INDUSTRIES

463 Scarborough Beach Road.

Osborne Park.

Western Australia. 6017.

Tel: **61 8 9204 1011** Fax: **61 8 9204 1013**

Email: **sales@holmanindustries.com.au**